

R5000 Series

R5016MG-25M-RGG01E

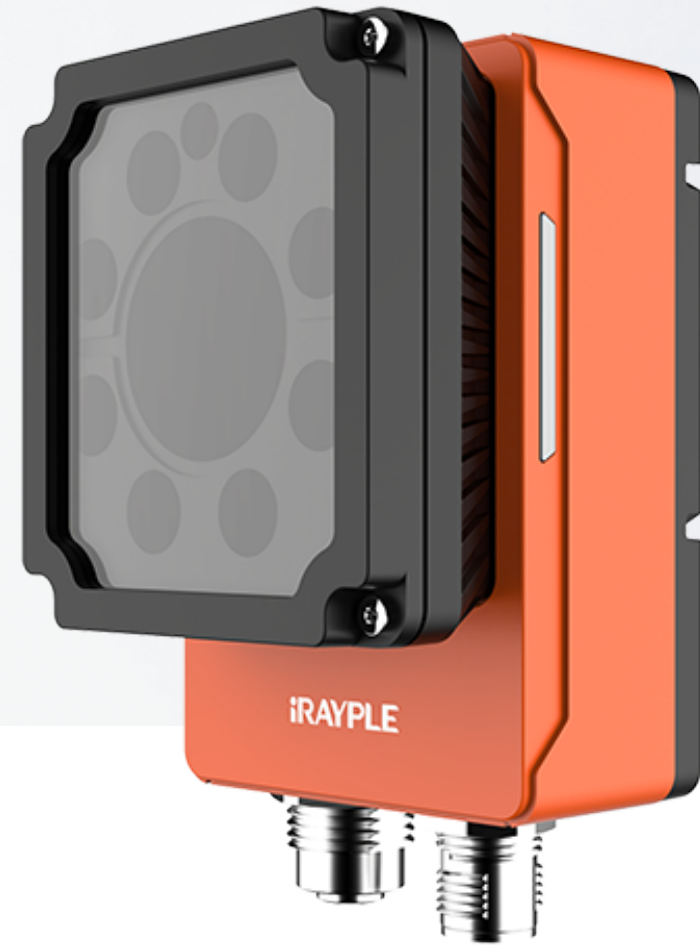

Features

- Light-integrated design makes red/white/blue illumination optional, support control separately
- Support different focal lengths, electrical auto focus and one-click auto training
- GigE interface, IP65 protection level
- Abundant IO interfaces such as Ethernet, RS232, GPIO, support multiple communication protocols
- Support various code formats and evaluations of code quality
- Built-in deep-learning algorithms and multi-parameters polling to ensure effects of complex applications

Dimensions (mm)

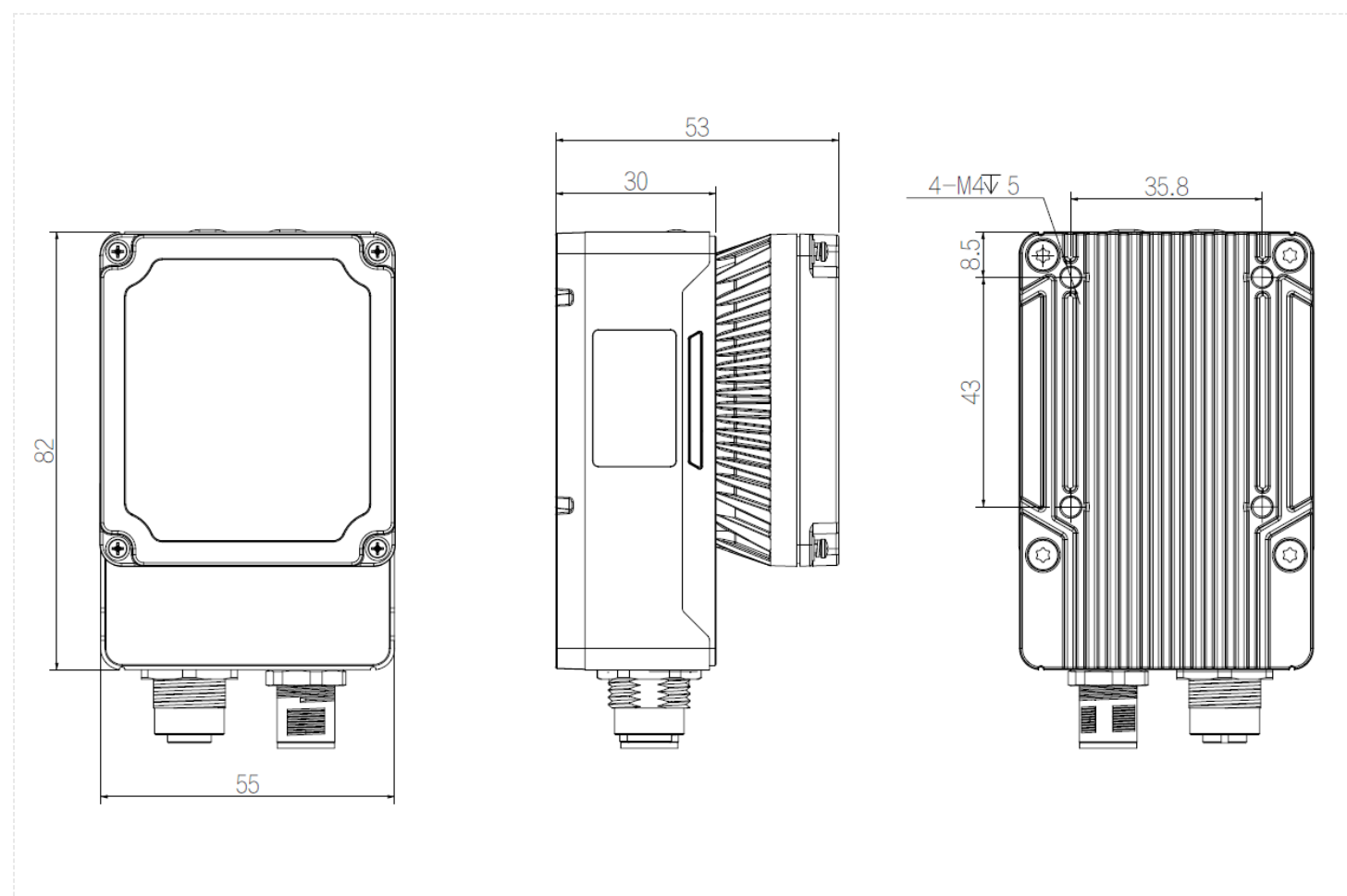

Specification

Model		R5016MG-25M-RGG01E
Basic	Resolution	1440 × 1080
	Max. Frame rate	60 fps
	Shutter Mode	Global
	Mono/Color	Mono
	Lens Mount	M12, auto focus
	Trigger Mode	Software trigger/External trigger/Free run modes
	Software	EasyID
	Certifications	CE , FCC , KC
	Function	ID: Code 39/Code 93/Code128/CodaBar/EAN8/EAN13/UPCA/UPCE/ITF25/2of5 (Industrial2of5) /standard25/GS1-128 etc. and 2D: Data Matrix/MQR/GS1 DM/GS1QR etc.; Quality Evaluation: ISO/IEC 29158(AIM-DPM), ISO/IEC 15415, ISO/IEC 15416)
Performance	Focal Length	25 mm
	Operating Distance	150-250 mm
	FoV	36×27 mm@WD200 mm
	Max. Read Speed	90 codes/s
	Max. Operating Speed	3 m/s
	Light Source type	Red, Polarized/Non-polarized
Port	Connector	2 Industrial connectors support GigE and GPIO
	Network Port	GigE
	GPIO Interface	RS232, 2 Opto-isolated inputs and 3 Opto-isolated outputs
	Communication Mode	RS232, Ethernet
	Communication protocol	SDK , TCP Client , TCP Server , FTP , RS232 , Profinet、 Modbus、 EtherNet/IP、 MC(SLMP)、 FINS/UDP、 FINS/TCP
	LED Indicator	Power,Ethernet,Status,Result
Power	Power Supply	9~26VDC, 2A input, suitable for industrial environment
	Power Consumption	<18 W(light included)
Structure	Product Dimensions	82 mm×55 mm×53 mm(not including connector)
	Net Weight	< 350 g
	Protection	IP65
	Casing Material	Aluminum alloy + Front cover
Environment	Operating Temperature	-20°C ~ +50°C
	Operating Humidity	20% ~ 95%(no condensation)
	Storage Temperature	-30°C ~ +70°C

Connector Pin-out

12 Pin I/O Connector

Color	Pin	Signal	Description
Brown white	1	OPT_OUT2	Opto-isolated output2
Grey	2	RS232_TXD	RS232 serial send
Purple	3	RS232_RXD	RS232 serial receive
Black white	4	SIGNAL_GND	RS232 serial GND
Yellow	5	OPT_IN1	Opto-isolated input1
Purple white	6	OPT_IN_GND	Opto-isolated input GND
Red	7	POWER	Power supply
Black	8	POWER_GND	Power supply GND
Green	9	OPT_OUT_GND	Opto-isolated output GND
Orange	10	OPT_IN0	Opto-isolated input0
Blue	11	OPT_OUT0	Opto-isolated output0
Brown	12	OPT_OUT1	Opto-isolated output1
White	-	-	Shield GND

